



Connection options

Angry Audio StudioHub plus XLR HD Breakout Boxes

3 models to choose from*:

16-XLRF (16 female XLR+16 SH)

16-XLRM (16 male XLR+16 SH)

8-XLRF, 8-XLRM (8 female, 8 male XLR+16 SH)

Analog

Front:XLR
Back:StudioHub



CBL4088: VHDCI to 4 x DB25

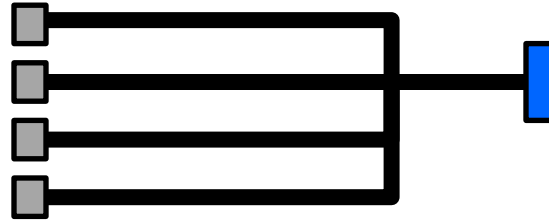





AES/EBU + GPIO

Front:XLR
Back:StudioHub

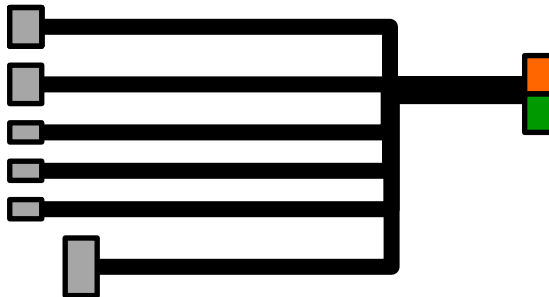

CBL4188: VHDCI to 2 x DB25, 2 x BNC, 1 x XLRF, 1 x Centronics (GPIO)



-  Blue = Analog
-  Orange = AES/EBU
-  Green = GPIO

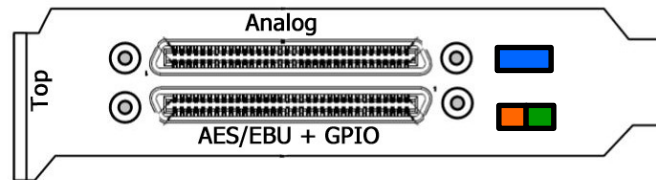

*Available direct from Angry Audio at angryaudio.com



Connection options Angry Audio StudioHub plus XLR HD Breakout Boxes

3 models to choose from*:

16-XLRF (16 female XLR+16 SH)

16-XLRM (16 male XLR+16 SH)

8-XLRF, 8-XLRM (8 female, 8 male XLR+16 SH)

Analog

Front:XLR
Back:StudioHub



CBL4088: VHDCI to 4 x DB25

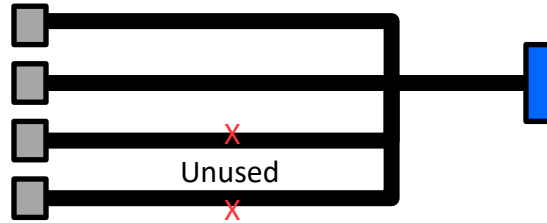





AES/EBU + GPIO

Front:XLR
Back:StudioHub

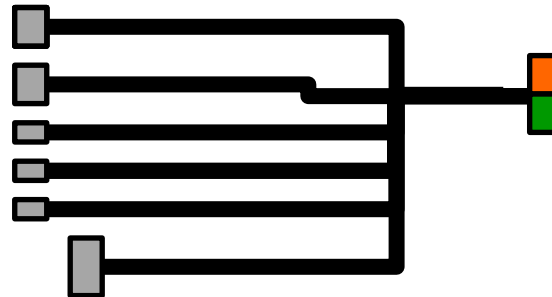

CBL4188: VHDCI to 2 x DB25, 2 x BNC, 1 x XLRF, 1 x Centronics (GPIO)



-  Blue = Analog
-  Orange = AES/EBU
-  Green = GPIO

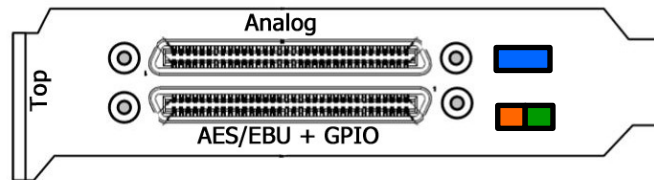

*Available direct from Angry Audio at angryaudio.com



Connection options for the ASI5720/ASI5722 and ASI6720/ASI6722

Analog

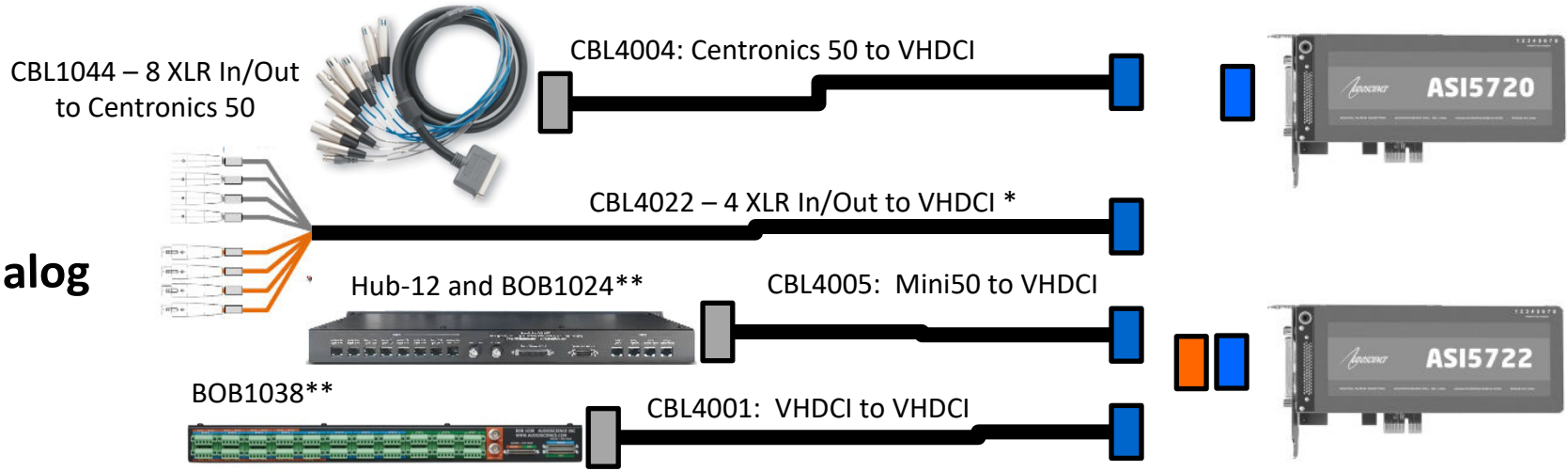

AES/EBU + GPIO

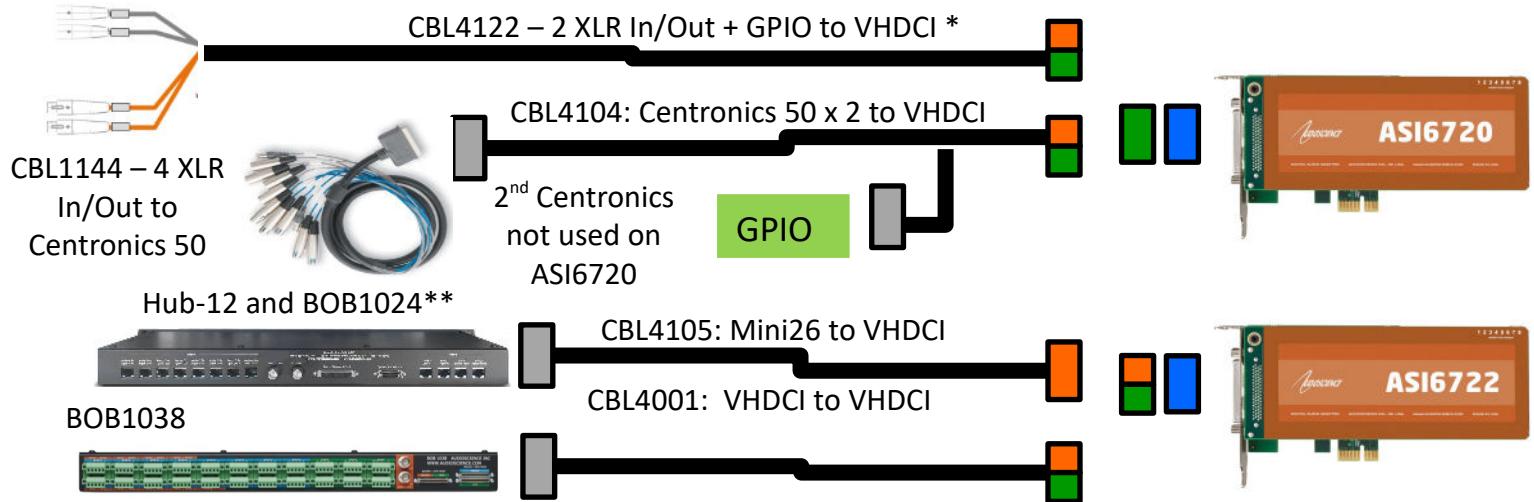

■ Blue = Analog
 ■ Orange = AES/EBU
 ■ Green = GPIO

* Recommended cable for this group

**Discontinued legacy product – See StudioHub replacement info

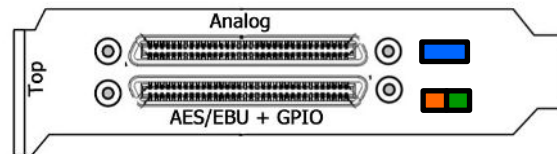



Connection options for the ASI5740/ASI5741/ASI5744 and ASI6714/ASI6718/ASI6740/ASI6744

Analog

CBL1044 – 8 XLR In/Out
to Centronics 50*



CBL4004: Centronics 50 to VHDCI



BOB1038**



CBL4001: VHDCI to VHDCI

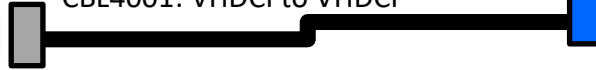

Hub-12 and BOB1024**



CBL4005: Mini50 to VHDCI

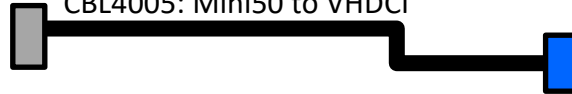

BOB1038**



CBL4001: VHDCI to VHDCI

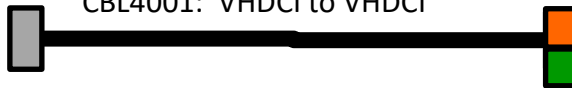

AES/EBU +GPIO

CBL1144 – 4 XLR
In/Out to
Centronics 50*



CBL4104: Centronics 50 x 2 to VHDCI



2nd Centronics
not used on
ASI6740

GPIO

Hub-12 and BOB1024**



CBL4105: Mini26 to VHDCI

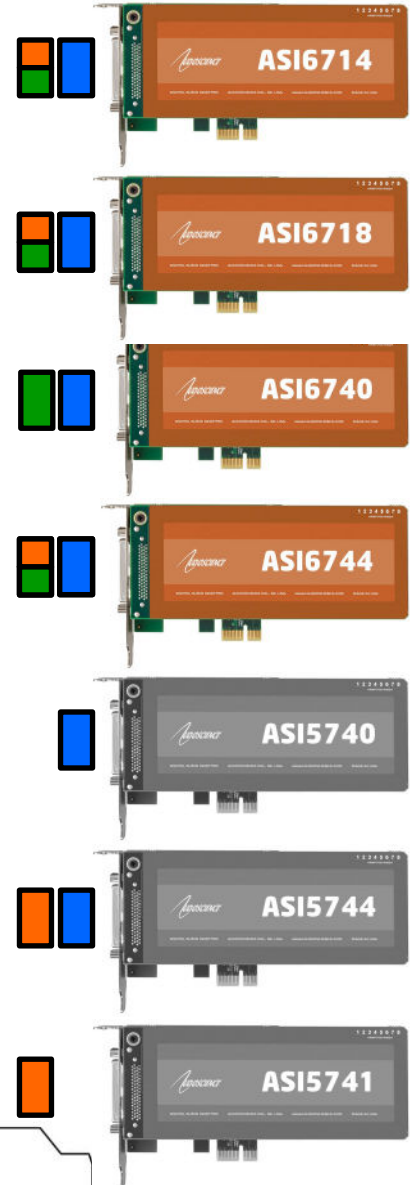
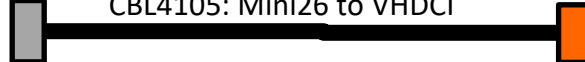

■ Blue = Analog ■ Orange = AES/EBU ■ Green = GPIO

* Limited to 4 outputs when used with ASI6718

**Discontinued legacy product – See StudioHub replacement info

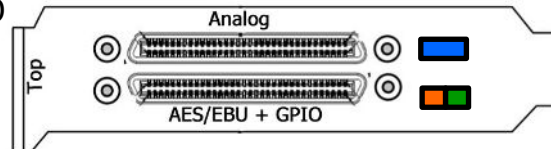

Connection options

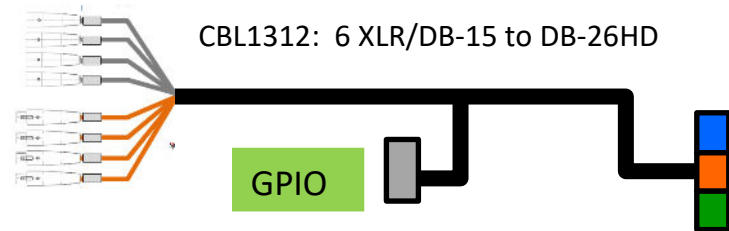

ASI5810/ASI5811/ASI5812

**Analog
AES/EBU
+ GPIO**

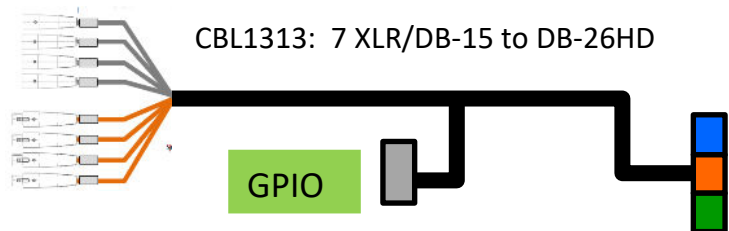

**Analog
AES/EBU
+ GPIO**



-  Blue = Analog
-  Orange = AES/EBU
-  Green = GPIO

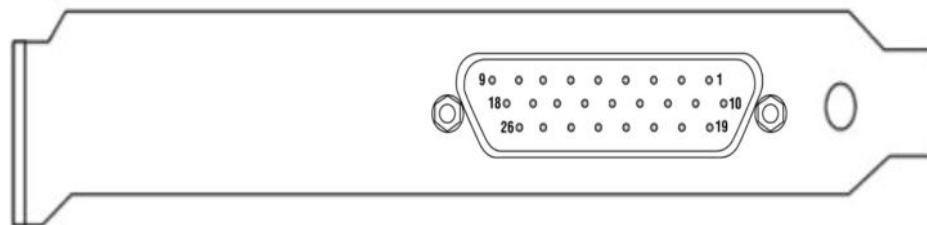

Connection options

ASI5780/ASI5788 and ASI6788/ASI6718

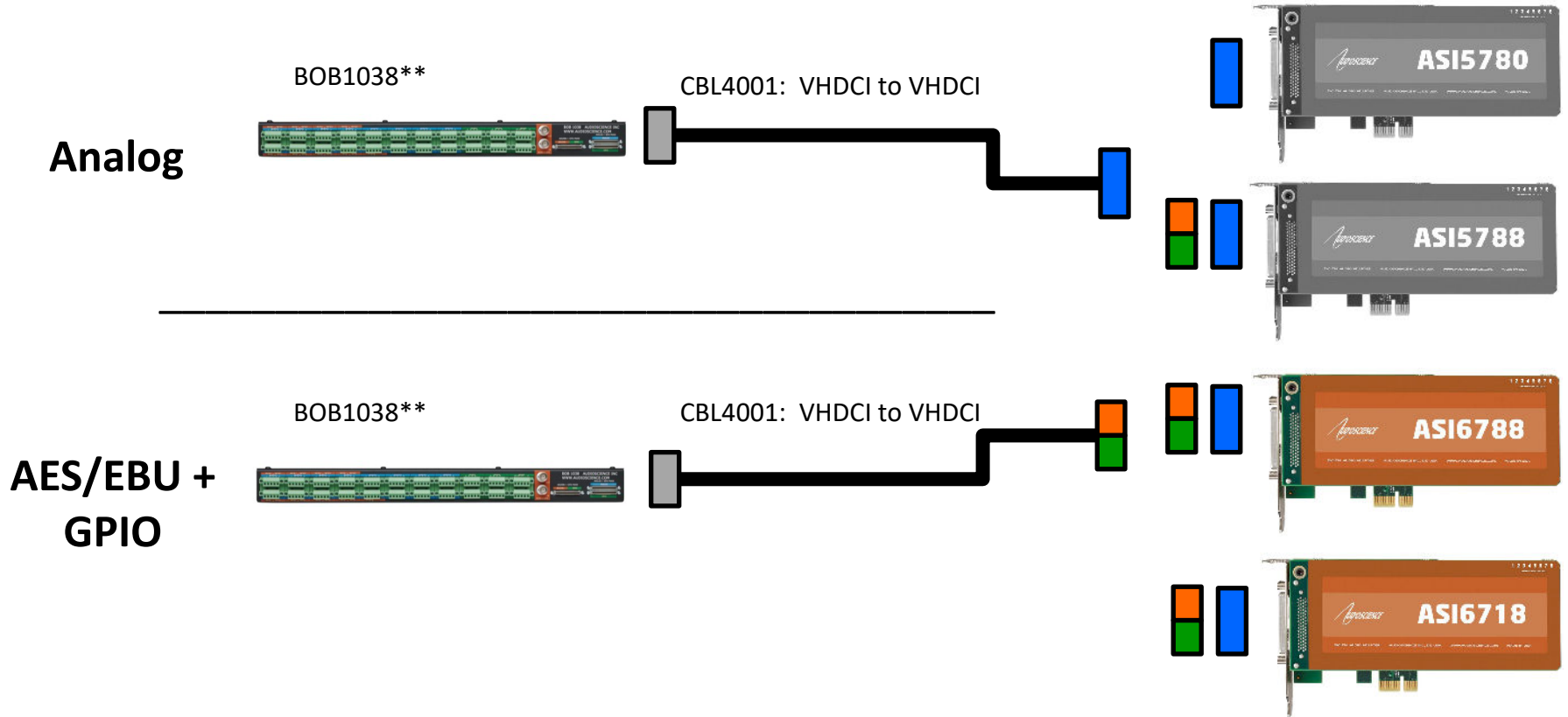

■ Blue = Analog
 ■ Orange = AES/EBU
 ■ Green = GPIO

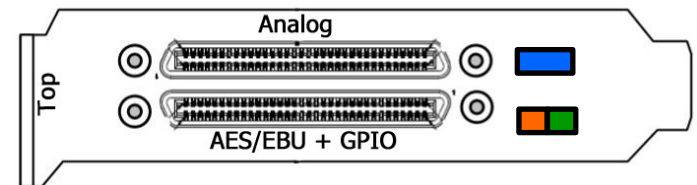

**Discontinued legacy product – See StudioHub replacement info



Connections ASI57xx and ASI67xx

Front of card (label side)

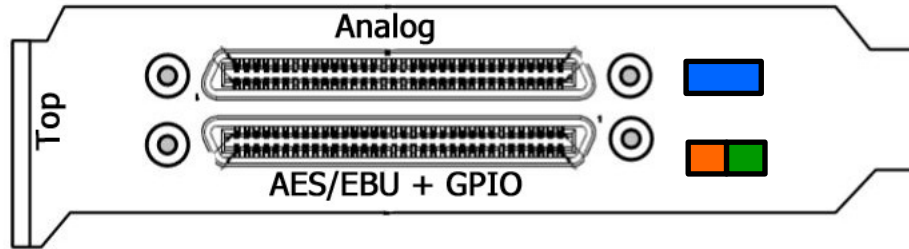

Back of card



Blue = Analog



Orange = AES/EBU



Green = GPIO



Connection options for the ASI56xx/66xx

CBL1044 – 4 stereo/8 XLR In/Out

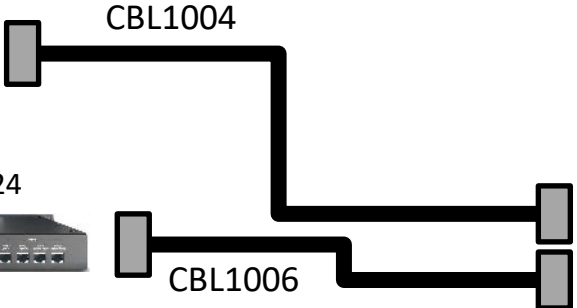

Analog

CBL1144 – 4 stereo/ 4 XLR In/Out

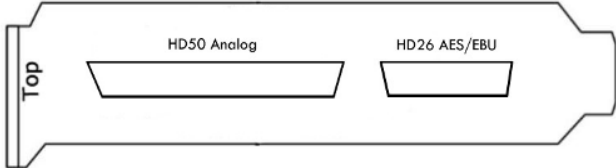
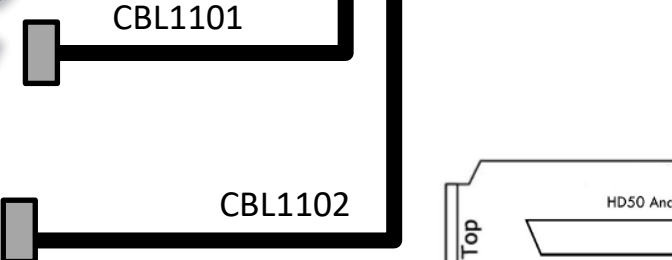

AES/EBU